

---

---

**INSTRUCTION AND PARTS MANUAL**  
**MODEL H18**  
**PLANETARY HYDRAULIC WINCH**



A  COMPANY

**THE LOGICAL CHOICE**

**PULLMASTER WINCH CORPORATION**  
8247-130th Street, Surrey, B.C. V3W 7X4, Canada  
Telephone: 604-594-4444 Fax: 604-591-7332  
Website: [www.pullmaster.com](http://www.pullmaster.com)  
E-mail: [sales@pullmaster.com](mailto:sales@pullmaster.com)



**READ THIS MANUAL BEFORE INSTALLING, OPERATING OR  
SERVICING THIS PRODUCT. THIS MANUAL CONTAINS IMPORTANT  
INFORMATION. MAKE THIS MANUAL AVAILABLE TO ALL PERSONS  
RESPONSIBLE FOR THE OPERATION, INSTALLATION, SERVICING  
AND MAINTENANCE OF THIS PRODUCT.**

# Pullmaster Limited Warranty

Effective 8/1/2008  
SUPERSEDES ALL PRIOR WARRANTIES

Seller warrants that each article (whether Gear Drive Products, Brake Products and/or Winch Products, all of which are covered hereunder) sold under this order shall at the time of shipment (i) conform to applicable specifications, and (ii) be free from defects in material and workmanship during normal and ordinary use and service (the "Warranty").

Buyer's exclusive remedy and Seller's sole obligation under this Warranty shall be, at Seller's option, to repair or replace any article or part thereof which has proven to be defective, or to refund the purchase price of such article or part thereof. Buyer acknowledges that Buyer is knowledgeable concerning the articles covered by this Warranty and sold in connection therewith which are being purchased, that Buyer has reviewed this Warranty and that the remedies provided hereunder are adequate and acceptable to Buyer.

This Warranty shall expire one (1) year from the date the article is first shipped by Seller. Notice of claimed breach of this Warranty must be given by Buyer to Seller within the applicable period. Such notice shall include an explanation of the claimed warranty defect and proof of date of purchase of the article or part thereof for which warranty coverage is sought. No allowances shall be made by Seller for any transportation, labor charges, parts, "in and out" costs, adjustments or repairs, or any other work, unless such items are authorized in writing and in advance by Seller. Nor shall Seller have any obligation to repair or replace items which by their nature are expendable.

If an article is claimed to be defective in material or workmanship, or not to conform to the applicable specifications, Seller will either examine the article at Buyer's site or issue shipping instructions for return to Seller. This Warranty shall not extend to any articles or parts thereof which have been installed, used, or serviced otherwise than in conformity with Seller's applicable specifications, manuals, bulletins, or instructions, or which shall have been subjected to improper installation, operation, or usage, misapplication, neglect, incorrect installation, overloading, or employment for other than normal and ordinary use and service. This Warranty shall not apply to any article which has been repaired, altered or disassembled, or assembled by personnel other than those of Seller. This Warranty shall not apply to any article upon which repairs or alterations have been made (unless authorized in writing and in advance by Seller). This Warranty shall not apply to any articles or parts thereof furnished by Seller to Buyer's specifications and/or furnished by Buyer or acquired from others at Buyer's request.

SELLER MAKES NO EXPRESS WARRANTIES AND NO IMPLIED WARRANTIES OF ANY KIND, OTHER THAN THE WARRANTY EXPRESSLY SET FORTH ABOVE. SUCH WARRANTY IS EXCLUSIVE AND IS MADE AND ACCEPTED IN LIEU OF ANY AND ALL OTHER WARRANTIES, EXPRESS OR IMPLIED, INCLUDING WITHOUT LIMITATION THE IMPLIED WARRANTIES OF MERCHANTABILITY AND FITNESS FOR A PARTICULAR PURPOSE.

Buyer expressly agrees that Seller is not responsible to perform any work or investigation related in any way to tensional vibration issues and is not responsible for the detection or remedy of Natural Frequency Vibration of the mechanical system in which the unit is installed. Buyer acknowledges, understands and agrees that this Warranty does not cover failures of the unit which result in any manner from the operation of the machine or unit at vibration frequencies at or near the natural frequency vibration of the machine in such a way that damage may result. Buyer expressly agrees that Seller is not responsible for failure damage or accelerated wear caused by machine or ambient vibration. Further, Buyer acknowledges and agrees that Buyer is always solely responsible for determination and final approval of the "application factor" which may be used in Seller's calculations, and this application factor is 1.0 unless otherwise stated in Seller's quotation specifications.

The remedies for this Warranty shall be only those expressly set forth above, to the exclusion of any and all other remedies of whatsoever kind. The limited remedies set forth above shall be deemed exclusive, even though they may fail their essential purpose. No agreement varying or extending the foregoing Warranty, remedies, exclusions, or limitations shall be effective unless in a writing signed by an executive officer of Seller and Buyer. This Warranty is non-transferable. If a party who had purchased articles from Buyer, or from persons in privity with Buyer, brings any action or proceeding against Seller for remedies other than those set forth in this Warranty, Buyer agrees to defend Seller against the claims asserted in such action or proceeding at Buyer's expense, including the payment of attorneys' fees and costs, and indemnify Seller and hold Seller harmless of, from and against all such claims, actions, proceedings or judgments therein. Buyer also agrees to defend and indemnify Seller of, from and against any loss, cost, damage, claim, debt or expenses, including attorneys' fees, resulting from any claims by Buyer or third parties to property or injury to persons resulting from faulty installation, repair or modification of the article and misuse or negligent operation or use of the article, whether or not such damage to property or injury to persons may be caused by defective material, workmanship, or construction. **ADVISORY:** *Winches and hoists are not approved for lifting or handling personnel or persons unless specifically approved in writing from Seller for the specific intended application.*

Under no circumstances shall Seller be liable (i) for any damage or loss to any property other than the warranted article or part thereof, or (ii) for any special, indirect, incidental, or consequential damage or loss, even though such expenses, damages, or losses may be foreseeable.

The foregoing limitations on Seller's liability in the event of breach of warranty shall also be the absolute limit of Seller's liability in the event of Seller's negligence in manufacture, installation, or otherwise, with regard to the articles covered by this Warranty, and at the expiration of the Warranty period as above stated, all such liabilities shall terminate. Buyer's purchase of any article(s) covered by this Warranty shall constitute acceptance of the terms and conditions hereof and shall be binding upon Buyer and Buyer's representatives, heirs and assigns. The laws of the Province of British Columbia shall govern Buyer's rights and responsibilities in regard to this Warranty and the transaction(s) subject thereto, and the Province of British Columbia shall be the exclusive forum and jurisdiction for any action or proceedings brought by Buyer in connection herewith or any dispute hereunder. If any of the terms and conditions contained within this Warranty are void, the remaining provisions thereof are and shall remain valid and enforceable.

**Note:** *Prices and specifications contained in this price book are subject to change without notice.*

# SAFETY RECOMMENDATIONS



**DANGER**

**FAILURE TO COMPLY WITH THE FOLLOWING SAFETY RECOMMENDATIONS AND LOCAL RULES AND REGULATIONS WILL RESULT IN PROPERTY DAMAGE, SEVERE INJURY OR DEATH.**



Definition: **Caution** indicates a potentially hazardous situation which, if not avoided may result in minor or moderate injury.



Definition: **Warning** indicates a potentially hazardous situation which, if not avoided could result in death or serious injury.



Definition: **Danger** indicates a potentially hazardous situation which, if not avoided will result in death or serious injury.

The planetary hydraulic winches are made for hoisting and lowering loads and to be operated by trained and professional personnel. They are not designed for operations involving lifting or moving personnel. The winches are powered by hydraulic power. The ropes / cables for hoisting operations are not supplied by PULLMASTER. The winches are always assembled in an application, they do not function as an independent machine and it is not allowed to use them as such.

The winches are to be used within the specifications as listed in the manual under "SPECIFICATIONS". Other use as foreseen in the functional description of the hydraulic winch is not allowed without written permission from PULLMASTER.

1. Do not install, operate or service winch before reading and understanding manufacturer's instructions.
2. The winch described herein is not designed for operations involving lifting or moving personnel.
3. Do not lift or carry loads over people.
4. Do not exceed recommended operating pressure (psi) and operating volume (gpm).
5. Do not jerk the winch. Always smoothly accelerate and decelerate load.
6. Do not operate a damaged, noisy or malfunctioning winch.
7. Do not leave a load suspended for any extended period of time.
8. Never leave a suspended load unattended.
9. Winch should be maintained and operated by qualified personnel.
10. Inspect winch, rigging, mounting bolts and hoses before each shift.
11. Warm-up equipment before operating winch, particularly at low ambient temperatures.
12. Verify winch function by raising and lowering a full test load to a safe height before each shift.
13. Do not weld any part of the winch.
14. Verify gear lubrication and brake circulation supply and return before operating winch.
15. Be sure of equipment stability before operating winch.
16. Wear proper clothing to avoid entanglement in rotating machinery.
17. Always stand clear of the load.
18. Use only recommended hydraulic oil and gear lubricant.
19. Keep hydraulic system clean and free from contamination at all times.
20. Maintain winch and equipment in good operating condition. Perform scheduled maintenance regularly.
21. Keep hands clear when winding wire rope onto the winch drum.
22. Do not use the wire rope as a ground for welding.
23. Rig the winch carefully. Ensure that the wire rope is properly anchored to the correct cable anchor slot at the cable drum.
24. Do not lift a load with a twisted, kinked or damaged wire rope.
25. Consult wire rope manufacturer for size, type and maintenance of wire rope.
26. Maintain five wraps of wire rope on the cable drum at all times.
27. In case of a power failure or breakdown leading to an unexpected stop of the hydraulic power circuit, stand clear of the area and the load being hoisted, take the necessary precautions to prevent access to area where the load is halted.
28. The noise level of the winch is 86 dBA measured on a distance of 1.00 meter, 1.60 meters high. The measuring equipment used was: Realistic #42-3019.
29. Clean up any oil spillage immediately.
30. Wear proper clothing and personal protection equipment such as, footwear, safety goggles and a hard hat. Read manual first.



# DESCRIPTION OF THE MODEL H18

## GENERAL DESCRIPTION:

The PULLMASTER Model H18 is a planetary, hydraulic winch with reversing or lowering speed 4.6 times faster than forward or hoisting speed. The main components of this unit are:

- + hydraulic gear motor
- + multi-disc brake with static and dynamic function
- + primary planet reduction
- + final planet reduction
- + brake housing
- + final drive housing
- + cable drum

## FUNCTION IN FORWARD ROTATION (HOISTING):

In forward rotation, the output torque and rpm of the hydraulic motor are transmitted to the sun gear of the primary planet reduction. The output torque and rpm of the primary reduction stage are transmitted to the final reduction stage by the final sun gear shaft, which is splined to the primary planet hub. In forward rotation, or when a load is raised, an over-running clutch, which connects the motor drive shaft to the automatic brake assembly, permits free rotation of the sun gear without effecting the brake. When the winch rotation is stopped, the load on the cable drum causes the over-running clutch to lock and the maximum load is held safely by the disc brake.

## FUNCTION IN REVERSE ROTATION (LOWERING):

In reverse rotation, hydraulic pressure from the reversing side of the hydraulic motor is channelled to the brake piston, causing the brake piston to release the multi-disc brake against a number of brake springs. The over-running clutch, connecting the motor drive shaft with the internal gear of the primary planet reduction locks, causing the internal gear to rotate at the same rpm as the primary sun gear. Thus, the primary reduction stage is eliminated and the output torque and rpm of the hydraulic motor are transmitted directly to the final planet reduction stage. With the primary reduction stage eliminated, the reduction is reduced to a ratio of 8.6:1 and the cable drum will rotate 4.6 times faster than in forward or hoisting speed.

If the load on the cable drum tends to effect the lowering speed, the resulting pressure drop in the brake piston causes friction between the brake discs and divider plates. In this way, a completely smooth lowering speed can be achieved in a stepless operation by modulation of the winch control handle. When the control handle is returned to neutral position, rotation stops and the disc brake applies automatically.

During the lowering operation of the winch, the friction created by the brake discs results in temperature. This temperature is dissipated by an internal circulation flow, supplied out of the hydraulic motor or from an external source. For models with external circulation the required flow is approximately 7 (US) gpm - 26 l/min. This circulation flow must be returned directly to the reservoir with a permissible back pressure of 30 psi (2 bar).

**IMPORTANT:** Under no circumstances must the back pressure in the brake housing be permitted to exceed 30 psi (2 bar). Excessive pressure in the brake housing will damage the oil seal separating the brake housing from the drum interior. Damage to this seal will cause the drum to fill up with hydraulic fluid. In order to prevent potential damage to the drum seals and the end cover of the winch, when the cable drum fills up with hydraulic fluid, a breather relief (see PARTS REFERENCE, item 130) is installed on the end cover. The breather relief bleeds to atmosphere and serves as a warning signal that the oil seal between the brake housing and drum has been damaged.

# EXPLANATION OF MODEL CODING

**H 18 X - XX - XX - XX X - X XXXX**

**BASIC UNIT SERIES** \_\_\_\_\_

H = Rapid reverse

**SIZE OF UNIT** \_\_\_\_\_

**REDUCTION RATIO** \_\_\_\_\_

Only used for non standard reduction ratios

**TYPE OF BRAKE** \_\_\_\_\_

- 3 Automatic brake, clockwise drum rotation, internal circulation flow
- 4 Automatic brake, external brake release, clockwise drum rotation, internal circulation flow
- 5 Automatic brake, external brake release, counterclockwise drum rotation, internal circulation flow
- 6 Automatic brake, counterclockwise drum rotation, internal circulation flow
- 7 Automatic brake, clockwise drum rotation, external circulation flow
- 8 Automatic brake, external brake release, clockwise drum rotation, external circulation flow
- 9 Automatic brake, external brake release, counterclockwise drum rotation, external circulation flow
- 10 Automatic brake, counterclockwise drum rotation, external circulation flow

**HYDRAULIC MOTOR** \_\_\_\_\_

- 101 *COMMERCIAL M365* hydraulic motor, 2.25 inch gear section  
(Other gear sections for this motor are optional)

**DRUM SIZE** \_\_\_\_\_

- 1 8 1/2 inch drum diameter X 15 1/2 inch flange diameter X 10 inch length - STANDARD  
(For other drum sizes refer to APPENDIX A)

**OPTIONS** \_\_\_\_\_

- F Hydraulically actuated **freespooling**

**DESIGN REVISION** \_\_\_\_\_

**SPECIFICATION NUMBER** \_\_\_\_\_

Describes features not identified by preceding codes

**NOTE:** Clockwise and counterclockwise drum rotation is the direction of rotation for pulling or hoisting, established by looking at the hydraulic motor.

# OPTIONS

## COUNTERCLOCKWISE ROTATION:

The drum rotation of the standard PULLMASTER Model H18 planetary winch is clockwise for hoisting when looking at the hydraulic motor of the winch. Drum rotation for counterclockwise hoisting direction is available as an option.

## EXTERNAL BRAKE RELEASE:

PULLMASTER planetary winches can be supplied with an **external brake release** which permits release of the automatic disc brake from an external pressure source.



**FAILURE TO PROPERLY VENT EXTERNAL BRAKE RELEASE PORT WILL TRAP BRAKE PRESSURE AND ALLOW THE LOAD TO DROP, CAUSING PROPERTY DAMAGE, SEVERE INJURY OR DEATH. WINCHES SUPPLIED WITH EXTERNAL RELEASE OPTION MUST BE CONNECTED ACCORDING TO TYPICAL HYDRAULIC CIRCUIT.**

## CABLE DRUM SIZES:

Aside from the standard drum sizes listed in APPENDIX A, the PULLMASTER Model H18 planetary winch can be supplied with optional drums to accommodate large wire rope storage capacity.

## DRUM GROOVING:

Cable drums for the PULLMASTER Model H18 planetary winch can be grooved. Where this option is a requirement, it is necessary to state the size of wire rope which is to be used with the winch.

## OPTIONAL GEAR SECTION FOR THE HYDRAULIC MOTOR:

The performance of the standard PULLMASTER Model H18 planetary winch may be changed by using a different displacement motor. (Contact the factory for performance information.)

## HYDRAULIC MOTORS FOR HIGH PRESSURE HYDRAULIC SYSTEMS:

The operating pressure of the PULLMASTER Model H18 planetary winch is limited to 2300 psi (159 bar). For hydraulic systems operating with a higher range of hydraulic pressure, the winch can be supplied with a hydraulic piston motor, which will provide for the same basic performance in terms of line pull and line speed capacity. (Contact the factory for this requirement.)

## FREESPOOLING:

This option permits wire rope being pulled off the cable drum by an operator. **Freespooling** should not be confused with **free fall**. The **freespool** clutch cannot be disengaged or re-engaged with a load on the wire rope or while the cable drum is turning.

The PULLMASTER WINCH CORPORATION will consider other options for quantity requirements.

# SPECIFICATIONS

Performance specifications are based on standard hydraulic motor, gear ratio and cable drum with 3/4 inch diameter wire rope. For other cable drums refer to APPENDIX A. For other reductions or motors, refer to supplement inside back cover. Performance specifications for winches supplied with optional motors are provided in attached supplement.

**CABLE DRUM DIMENSIONS (STANDARD DRUM):**

Barrel diameter	8.50 in	216 mm
Flange diameter	15.50 in	394 mm
Barrel length	10.00 in	254 mm

**CABLE STORAGE CAPACITY:**

<b>(Size of wire rope)</b>		
	3/8 in	615 ft / 187 m
	7/16 in	494 ft / 151 m
	1/2 in	332 ft / 101 m
	9/16 in	310 ft / 94 m
	5/8 in	239 ft / 73 m
	3/4 in	170 ft / 52 m
	7/8 in	113 ft / 34 m

**MAXIMUM OPERATING PRESSURE:** 2300 psi / 159 bar

**MAXIMUM OPERATING VOLUME:** 76 (US) gpm / 288 l/min

**MINIMUM OPERATING VOLUME:** 20 (US) gpm / 76 l/min

**DRUM TORQUE AT MAXIMUM PRESSURE:** 83,250 lb-in / 9,406 Nm

**DRUM RPM AT MAXIMUM VOLUME:**  
 Hoisting: 50.5 rpm  
 Lowering: 232 rpm

**HOISTING LINE PULL AT MAXIMUM PRESSURE:**

Bare drum	18,000 lb	80.1 kN
Full drum	11,288 lb	50.2 kN

**HOISTING LINE SPEED AT MAXIMUM VOLUME:**

Bare drum	122 fpm	37 m/min
Full drum	195 fpm	59 m/min

**PERMISSIBLE LOAD WHEN LOWERING**

<b>AT MAXIMUM VOLUME:</b>	Bare drum	3,913 lb / 17.4 kN
	Full drum	2,506 lb / 11.1 kN

**LOWERING LINE SPEED AT MAXIMUM VOLUME:**

Bare drum	563 fpm	171 m/min
Full drum	897 fpm	273 m/min

**PERMISSIBLE SYSTEM BACK PRESSURE AT MOTOR RETURN PORT:**

65 psi / 4.5 bar

**PERMISSIBLE PRESSURE AT CIRCULATION SUPPLY PORT:**

30 psi / 2 bar

**LUBRICATING OIL:** Refer to RECOMMENDATIONS for viscosity and instructions.  
 Refer to APPENDIX A for oil volume required.

# PERFORMANCE GRAPHS

PG-H18-A

## LINE PULL VS. OIL PRESSURE

NOTE: MAXIMUM ALLOWABLE LINE PULL WHEN LOWERING

Bare drum	3,913 lb	17.4 kN
Full drum	2,506 lb	11.1 kN

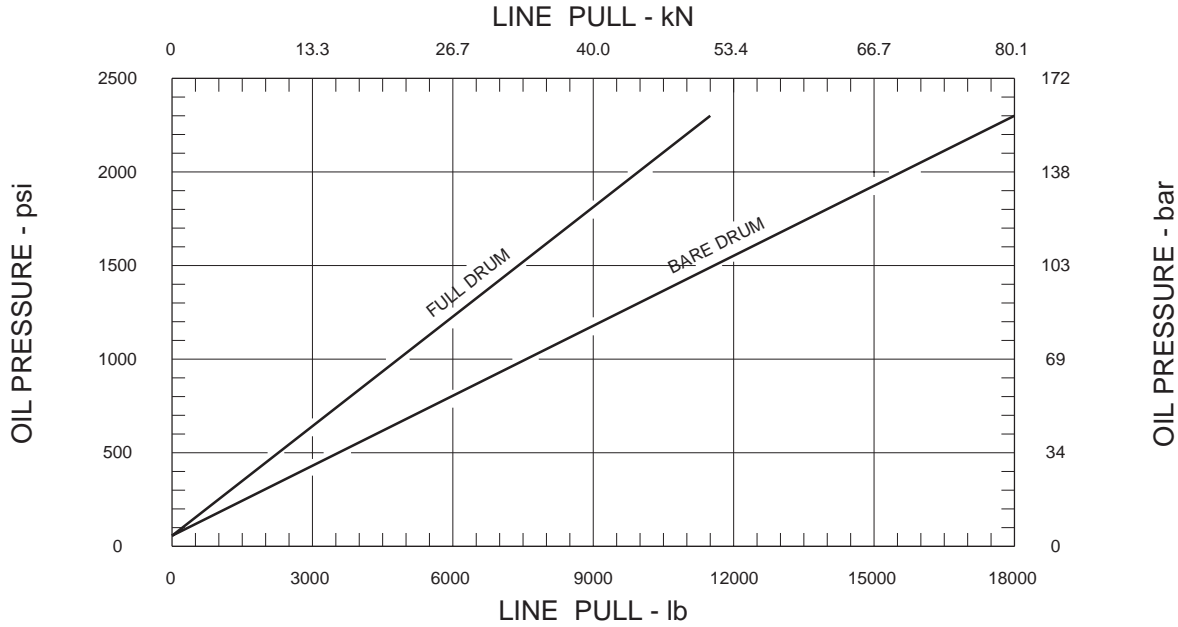

## LINE SPEED VS. OIL VOLUME

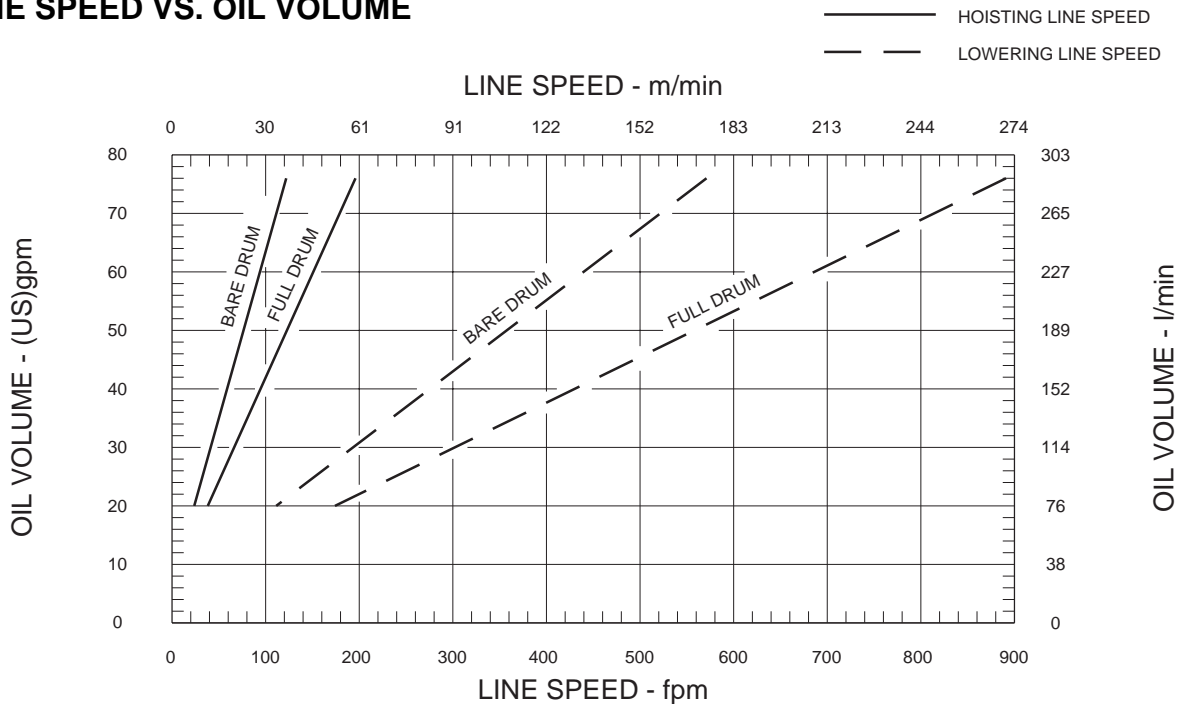

Performance graphs are based on standard hydraulic motor, gear ratio and cable drum with 3/4 inch diameter wire rope.

# TYPICAL HYDRAULIC CIRCUIT

HC-H18-C

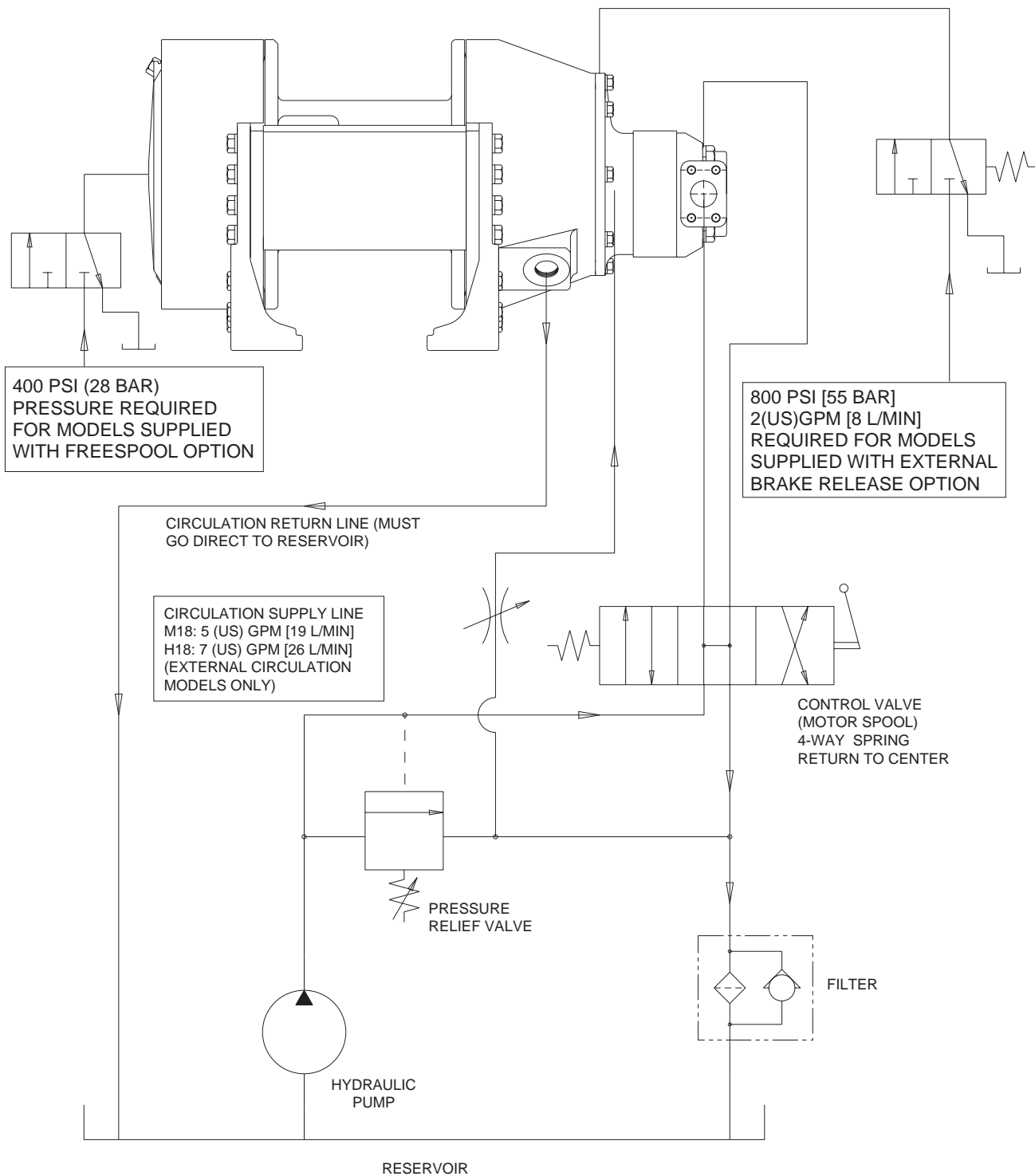

# RECOMMENDATIONS

## HYDRAULIC FLUID:

The hydraulic fluid selected for use with PULLMASTER planetary winches should be a high grade, petroleum based fluid, with rust, oxidation and wear resistance. Fluid cleanliness and operating viscosity are critical to winch reliability, efficiency and service life.

For optimum performance, the recommended viscosity range at operating temperature is 81 - 167 SUS (16 - 36 CS). For extreme operating conditions of short duration, the maximum viscosity range of 58 - 4635 SUS (10 - 1000 CS) should not be exceeded.

For optimum performance, the winch recommended hydraulic fluid temperature operating range is 80 - 150F (27 - 66 C). For extreme operating conditions of short duration, the maximum temperature range of -5 - 180F (-21 - 82 C) should not be exceeded.

## LUBRICATION:

The winch gear train requires oil bath lubrication. The winch is shipped from the factory without lubricating oil.

**IMPORTANT:** ADD LUBRICATING OIL BEFORE RUNNING WINCH.

Refer to INSTALLATION DIMENSIONS for location of lubricating oil fill port. Refer to APPENDIX A for quantity of oil required. For normal operating temperature use SAE 90 lubricating oil. For temperatures beyond normal operating range, consult lubricating oil supplier or factory.

## HYDRAULIC PUMP:

For maximum performance of the PULLMASTER planetary winch, the hydraulic pump must supply the maximum flow of hydraulic fluid at the hydraulic pressure stated in SPECIFICATIONS.

## HYDRAULIC CONTROL VALVE:

The standard control valve used for operation of the PULLMASTER planetary winch must have a four-way, spring return to neutral feature, which provides for open flow from the pressure ports of the winch to the reservoir in neutral position of the control (motor spool). It is important to point out that good speed control, especially when lowering a load, depends on the "metering" characteristics of the control valve. The better the oil flow is "metered" the better will be the speed control.

## HYDRAULIC PRESSURE RELIEF:

The hydraulic circuit for the PULLMASTER planetary winch requires a pressure relief set at the operating pressure (see SPECIFICATIONS). Usually, a pressure relief is part of the hydraulic control valve. Where this is not the case, a separate pressure relief valve must be installed and set at the recommended maximum pressure.

## HYDRAULIC RESERVOIR:

It is recommended that the hydraulic reservoir has sufficient capacity to provide good heat dissipation in order to prevent over-heating of the hydraulic fluid. The hydraulic reservoir should be made from clean and scale-free material to prevent contamination of the hydraulic fluid. In order to prevent air from being mixed with the hydraulic fluid, the reservoir should have an over-flow baffle separating the return lines from the suction line and all return lines should enter the reservoir below the fluid level. The reservoir should be mounted close to and above the hydraulic pump in a location which provides for free air circulation around the reservoir.

## HYDRAULIC HOSES:

The following hydraulic hoses are recommended for maximum efficiency of the PULLMASTER Model H18 planetary winch:

Pressure lines:	Equivalent to SAE 100R10-24
Circulation return line:	Equivalent to SAE 100R4-16
Circulation supply line*:	Equivalent to SAE 100R6-6

\*Only for models with external circulation

It is recommended that a larger size of hydraulic hose is installed where the pressure lines or the circulation lines are excessively long.

## HYDRAULIC FILTER:

Hydraulic filter recommendations for the hydraulic circuit of the PULLMASTER planetary winch, based on a return line filter, are given as follows:

Average Atmosphere:	10 microns
Dusty Atmosphere:	5 microns

## USE OF AN E STOP:

**(FOR EUROPEAN MACHINERY DIRECTIVE APPLICATIONS)**

The use of an E stop (emergency) is mandatory in the controls circuit. The E stop is to be placed in the operator's control panel. The E stop must be designed and placed in line with EN 60204 and EN 418.

# INSTALLATION INSTRUCTIONS



**DANGER**

**FAILURE TO FOLLOW INSTALLATION INSTRUCTIONS WILL  
RESULT IN PROPERTY DAMAGE, SEVERE INJURY OR DEATH.**

The initial installation or mounting of a PULLMASTER planetary winch is critically important for proper operation and performance. If the winch is mounted to an uneven surface, the centre line of the unit can be distorted to a point where the winch will not operate in either direction. It is therefore very important that the following instructions are observed when a PULLMASTER planetary winch is installed:

- 1) Make certain that the mounting platform is sufficiently strong in order to avoid deflection when a load is lifted.
- 2) Set the winch on the mounting platform and check for surface contact on all mounting pads of the winch.
- 3) If there is a space between the mounting surface and one of the mounting pads, the mounting surface is not even and the space below the mounting pad must be shimmed. If this condition exists, proceed as follows:
  - a) Install mounting bolts snug tight on the three mounting pads which are in contact with the mounting surface. (For mounting bolt size and grade see INSTALLATION DIMENSIONS.)
  - b) Measure the space underneath the fourth mounting pad with a feeler gauge and use shim stock of equivalent thickness in the space between the mounting pad and the mounting surface.
  - c) Only after this procedure should the fourth mounting bolt be installed. Tighten all four bolts per BOLT TORQUE CHART.
- 4) Fill the winch with lubricating oil. (See APPENDIX A for oil volume required.)
- 5) Use recommended circuit components and hydraulic hoses.
- 6) The circulation return line of the winch should be plumbed in such a manner that the brake housing remains full of oil at all times. Connect the return line directly to reservoir. Do not connect to a common return line.
- 7) Before operating the winch with a load, verify adequate circulation flow through the circulation return line as stated in TYPICAL HYDRAULIC CIRCUIT. Verify that pressure measured at the circulation supply port does not exceed the permissible pressure stated in SPECIFICATIONS. Winches equipped with the internal circulation option will supply circulation flow only when the winch is run in the lowering direction.
- 8) Verify that breather relief, item 130, is in place on end cover above oil level. Rotate end cover if breather relief is below oil level.

**IMPORTANT:** Do not replace breather relief with a pipe plug. The breather relief does not prevent oil seal failure but serves as an indicator or warning that the oil seals between brake housing and the cable drum interior have failed and must be replaced immediately. If these oil seals are changed, additional failure of the drum seal and potential damage to the end cover is prevented.

# OPERATING INSTRUCTIONS



**DANGER**

**FAILURE TO FOLLOW OPERATING INSTRUCTIONS WILL  
RESULT IN PROPERTY DAMAGE, SEVERE INJURY OR DEATH.**

After the PULLMASTER planetary winch has been installed in accordance with the INSTALLATION INSTRUCTIONS, the wire rope can be fastened to the cable drum.

**IMPORTANT:** The ropes, chains, slings, etc. are not part of the winch and are not covered by this manual. Refer to manufacturer's handling, inspection and maintenance recommendations to avoid potential accidents. For selection of ropes, etc. please check following product standards: DIN 15020, prEN818-1/9, prEN 1492-1/2, prEN 1677-1/3 and other relevant product standards.

- 1) The cable drum of the PULLMASTER planetary winch has two cable anchor slots, one for clockwise and one for counterclockwise hoisting. Standard rotation for hoisting is clockwise when looking at the hydraulic motor of the unit. It is critical to select the cable anchor slot which will permit winding of the wire rope on the drum in the correct direction of rotation. If the wire rope is wound on the cable drum in the wrong direction of rotation, the winch will have no braking capacity. Each winch is shipped from the factory with a label on the drum indicating the correct cable anchor slot.

## WIRE ROPE INSTALLATION

Clockwise hoisting winch shown.  
(Use cable anchor slot on opposite side of drum for counterclockwise hoisting winch.)

Feed the wire rope through the cable anchor slot. Loop rope back into slot as shown. Insert cable anchor into slot, small end first and long side nearest the drum flange. Pull rope tight to wedge rope in slot.

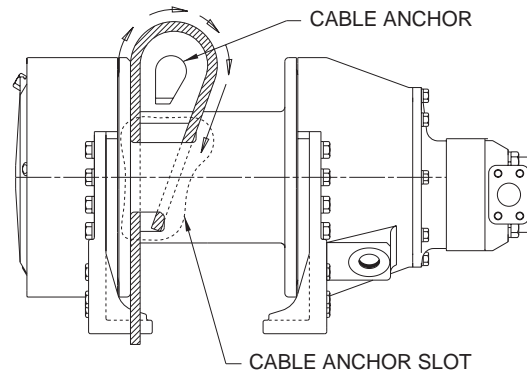

**SI1013-18**

- 2) On wire rope installation, care must be taken that the wire rope is wrapped completely around the cable anchor and properly pulled into the cable anchor slot in the cable drum. The cable drum requires 5 wraps of wire rope for safety.
- 3) The winch operation is controlled by a single control valve lever which has a **forward**, a **reverse** and a **neutral** position. Speed control in either direction is obtained by modulation of the control valve lever. Maximum line speed in either direction is obtained when the control valve lever is moved as far as it can go. The disc brake of the winch will come on automatically when the winch control lever is returned to **neutral**.
- 4) Always warm up equipment prior to operating winch, particularly in low ambient temperature. Circulate hydraulic oil through the winch control valve for several minutes to warm the hydraulic system. To prime the winch with warm oil, operate the winch at slow speed, forward and reverse, several times.
- 5) Prevent corrosion damage to winch interior. If not used regularly, run winch up and down at least once every two weeks.
- 6) To ensure proper winch installation and function, raise and lower a full test load to a safe height before using winch for regular operation at the start of each shift.

If, after a new installation, the winch does not function properly, refer to the TROUBLESHOOTING section of this manual.

# TROUBLE SHOOTING

**GENERAL:**

In most cases, when the hydraulic winch does not perform satisfactorily, the cause of malfunction is found somewhere in the hydraulic circuit. Before the winch is removed from its mounting and disassembled, all of the hydraulic circuit components should be checked for proper function.

**IMPORTANT:**

**The hydraulic oil volume relates to the line speed or rpm of the winch.**

Therefore, if the winch does not produce the specified maximum rated line speed or drum rpm, a loss of hydraulic flow somewhere in the hydraulic circuit can be analysed. If this condition exists, install a flow meter into the hydraulic circuit to check the volume of oil supplied to the pressure port of the hydraulic winch motor when the winch control is completely opened. The flow meter should indicate the maximum operating volume. If this test indicates a loss of hydraulic flow, check the hydraulic pump, the relief valve and the control valve. If the pump is driven by V-belts, check for belt slippage.

**The hydraulic pressure relates to the line pull or lifting capacity of the winch.**

If the winch will not produce the specified maximum line pull, install a pressure gauge in the pressure line leading to the hoisting port on the hydraulic winch motor. Stall the winch to prevent rotation of the drum and then open the control valve. Check the hydraulic pressure reading of the installed pressure gauge. If the pressure reads below the specified maximum operating pressure, look for trouble in the hydraulic pump, the relief valve and the control valve. If the hydraulic pump is driven by V-belts, check for belt slippage. When checking oil pressure and volume in the hydraulic circuit, verify that the hydraulic reservoir is filled to the top level and the hydraulic pump is running at maximum operating rpm.

Only if the hydraulic system has been checked and found to be in order, use the following indications for probable causes of failure in the winch:

FAILURE	PROBABLE CAUSE
<b>Winch will not produce line pull at maximum pressure as listed in SPECIFICATIONS.</b>	<ul style="list-style-type: none"> <li>a) Winch is mounted to an uneven surface (see INSTALLATION INSTRUCTIONS).</li> <li>b) Cable sheaves or block purchase operated with the winch are not turning freely.</li> <li>c) Damage or wear in the hydraulic motor.</li> <li>d) Excessive back pressure in the hydraulic system.</li> <li>e) Relief valve may be set too low (see SPECIFICATIONS for maximum operating pressure).</li> </ul>
<b>Winch does not produce line speed at maximum volume as listed in SPECIFICATIONS.</b>	<ul style="list-style-type: none"> <li>a) Winch is mounted to an uneven surface (see INSTALLATION INSTRUCTIONS).</li> <li>b) Cable sheaves or block purchase operated with the winch are not turning freely.</li> <li>c) Damage or wear in the hydraulic motor</li> <li>d) Excessive back pressure in the hydraulic circuit.</li> </ul>
<b>Winch will not reverse.</b>	<ul style="list-style-type: none"> <li>a) Leakage out of the brake piston prevents the disc brake from being released against the brake springs. This is caused by damaged O-ring seals on the brake piston.</li> <li>b) The O-ring seals, on the brake release channel between the motor adaptor and the brake housing, is damaged. If this failure occurs there will be substantial leakage from between the motor adaptor and brake housing.</li> <li>c) Insufficient hydraulic pressure (see SPECIFICATIONS for minimum operating pressure).</li> <li>d) Winch is mounted to an uneven surface (see INSTALLATION INSTRUCTIONS).</li> <li>e) Hydraulic pressure is not reaching the brake piston due to plugged brake release orifice in the brake housing.</li> </ul>

# TROUBLE SHOOTING CONTINUED

FAILURE	PROBABLE CAUSE
<b>Brake will not hold.</b>	<ul style="list-style-type: none"> <li>a) Brake plates or divider plates have been damaged by contamination in the hydraulic fluid, or lack of circulation flow in the brake housing.</li> <li>b) Brake piston is seized in the brake housing because of contamination in the hydraulic fluid.</li> <li>c) Excessive back pressure in the return line causes the brake to be released.</li> <li>d) Control valve has incorrect spool, which traps hydraulic pressure in the brake piston when the control valve handle is returned to neutral position. For proper function of the automatic brake, both pressure ports of the winch must be open to the reservoir in neutral position of the control valve.</li> <li>e) Wire rope is fastened to the incorrect cable anchor slot.</li> <li>f) Sprag clutch is damaged or surfaces where sprag clutch engages on motor drive shaft or connecting shaft are worn or indented.</li> <li>g) Winch supplied with external brake release option is not plumbed per HYDRAULIC CIRCUIT. Failure to vent external brake release port to reservoir may trap pressure and cause winch brake to slip.</li> </ul>
<b>Brake vibrates when lowering a load.</b>	<ul style="list-style-type: none"> <li>a) Pump is too slow. Pump rpm must be maintained at normal operating speed when a load is lowered.</li> <li>b) Brake is running too hot. This is caused by a complete lack of, or insufficient, circulation flow. To check the circulation, observe the flow of oil from the circulation return line of the winch (see TYPICAL HYDRAULIC CIRCUIT) when the winch is reversed.</li> <li>c) Control valve has poor metering characteristics.</li> <li>d) Damaged brake plates or divider plates.</li> <li>e) The over-running clutch, which connects the motor shaft with the brake assembly, is damaged.</li> <li>f) Air mixed with hydraulic oil (foamy oil).</li> </ul>
<b>Oil leaks.</b>	<ul style="list-style-type: none"> <li>a) Oil leaks from the hydraulic motor flange and the motor adaptor are caused by damaged O-ring seals.</li> <li>b) Oil leaks occurring between the cable drum flanges and housings are caused by excessive pressure in the brake housing. Excessive pressure will damage the oil seal which separates the brake housing from the cable drum interior.</li> <li>c) If the breather relief on the end cover leaks, the seal between the drum interior and the brake housing is damaged and must be replaced. This condition is caused by excessive pressure in the brake housing of the winch, operation with the incorrect hydraulic fluid during cold weather, or a restriction in the circulation return line leading back to tank.</li> </ul>

Refer to the SERVICE INSTRUCTIONS if it becomes necessary to disassemble the Model H18 winch.

# SERVICE INSTRUCTIONS

## GENERAL:

Before attempting disassembly of the PULLMASTER Model H18 planetary winch, the following instructions for disassembly and reassembly should be read and understood:

It is suggested that all expendable parts, such as O-rings and oil seals, are not reused on reassembly. It is therefore important to have a seal kit (Part No. 23135) and, providing the hydraulic motor has to be serviced, a seal kit (Part No. 23139) on hand before the unit is taken apart.

**NOTE:** Backup washers may be included with seal kit. Install with oil seals as per instructions. If not present in seal kit, the oil seals supplied do not require backup washers.

A clean working area is of prime importance, similar to conditions used for service work on any other hydraulic component. All parts, as they are removed from the winch assembly, should be inspected for wear and damage. Worn or damaged parts must be replaced. Thoroughly clean parts before reassembly. Do not use solvent to clean the brake friction plates.

During reassembly, lubricate all O-rings and oil seals with grease before installation.

In the following service instructions, reference to parts is made by numbers and shown on the applicable group drawings.

## DISASSEMBLY

For the majority of required service or repair work, disassembly is required only on the brake housing of the PULLMASTER Model H18 planetary winch. There are no special tools needed for the service or repair work and no adjustments or calibrations are necessary. Proceed with the disassembly as follows:

### DISASSEMBLY OF HYDRAULIC MOTOR ASSEMBLY:

If the analysed service or repair work requires access to the interior of the brake housing, the hydraulic motor should not be disassembled. In this case, the hydraulic motor should be removed together with the motor adaptor as a complete assembly. If a problem has been analysed to be in the hydraulic motor, proceed with the disassembly as follows:

1) Remove the four hex capscrews, item 951, together with the lockwashers, item 953, from the motor assembly.

**IMPORTANT:** Failure to exercise care when removing the motor port end cover or gear housing could permanently damage the machined surfaces of these motor components. Take care not to damage machined surfaces of motor components at disassembly.

2) Remove (pry loose if necessary) port end cover, item 870, together with two bushings, item 875. Two dowel pins, item 865, which are hollow for the capscrews to go through, will stay in either the port end cover or in the gear housing, item 861.

3) Remove gear set, item 881, which consists of two gears which are a matched set.

4) As the gears are removed, so is a thrust plate, item 885, two end seals, item 887, two side seals, item 891, and a backup seal, item 897. Discard end, side and backup seals.

5) Remove gear housing, item 861, together with gasket seals, item 869, and the remaining thrust plate with its end, side and backup seals. Discard the gasket, end, side and backup seals.

End, side, backup and gasket seals in the hydraulic motor assembly are not part of the winch seal kit. The seal kit for the hydraulic motor can be ordered from the factory under Part No. 23139. All parts of the hydraulic motor, with the exception of the motor adaptor, item 800, and the port end cover, item 870, are standard parts of the *COMMERCIAL M365* hydraulic motor, having a 2.25 inch gear section. All of these parts can be ordered from COMMERCIAL INTERTECH dealers in Canada, the United States and in most overseas areas. If there is no COMMERCIAL INTERTECH representation, all parts for the hydraulic motor can be ordered from the factory.

# SERVICE INSTRUCTIONS CONTINUED

## REMOVAL OF HYDRAULIC MOTOR ASSEMBLY:

If disassembly of the hydraulic motor is not necessary, proceed as follows:

- 1) Remove eight hex head capscrews, item 821, with lockwashers, item 823, from motor adaptor, item 800. Since the brake springs, item 752, apply pressure against the inside of the motor adaptor, it is recommended that the hex capscrews are unscrewed, one turn at a time, until the spring pressure has been released. The complete motor assembly, including the motor adaptor, can now be removed from the brake housing assembly.
- 2) Remove and discard three O-rings, item 801, and O-ring, item 707. (O-rings, item 801, seal the pressure transfer hole for the automatic brake release and are situated on the flange of the brake housing.)

## DISASSEMBLY OF BRAKE HOUSING ASSEMBLY:

- 1) After the motor assembly has been removed, all parts of the brake assembly are accessible. Remove 14 brake springs, item 752. Thoroughly examine springs for damage and measure overall length. Overall spring length should be 2.27 inch. If any spring measures less than 2.21 inch, replace all springs as a set.
- 2) Pull motor drive shaft, item 730, out of brake hub assembly. The surface of the motor drive shaft which engages the sprag clutch, item 723, should be inspected for wear or indentations. If the motor drive shaft shows any surface damage, it should be replaced.
- 3) Sprag clutch aligner, item 724, and sprag clutch, item 723, can now be removed from the bore of the brake connecting shaft, item 600. Inspect both parts for wear or damage and replace if necessary.



**DANGER**

**MINOR SURFACE DEFECTS WHERE THE SPRAG CLUTCH ENGAGES THE MOTOR DRIVE SHAFT AND CONNECTING SHAFT, WILL RESULT IN BRAKE FAILURE AND ALLOW THE LOAD TO DROP, CAUSING PROPERTY DAMAGE, SEVERE INJURY OR DEATH. THOROUGHLY INSPECT THESE AREAS AND, IF NECESSARY, REPLACE MOTOR DRIVESHAFT, SPRAG CLUTCH AND CONNECTING SHAFT AS A SET.**

- 4) Pull brake piston, item 750, out of brake housing using two 5/8-11NC bolts screwed into two puller holes in piston and discard O-rings, item 751 and item 753.
- 5) Thoroughly examine the inner bores of the brake housing and the outer diameters of the brake piston for scoring caused by hydraulic fluid contamination. Minor surface damage may be repaired by polishing with a fine emery cloth.



**DANGER**

**DAMAGED FRICTION OR DIVIDER PLATES WILL REDUCE BRAKING CAPACITY AND ALLOW THE LOAD TO DROP, CAUSING PROPERTY DAMAGE, SEVERE INJURY OR DEATH. SOLVENT MAY DAMAGE THE FRICTION PLATES. DO NOT USE SOLVENT TO CLEAN THE FRICTION PLATES. PERFORM THOROUGH INSPECTION AND, IF NECESSARY, REPLACE FRICTION AND DIVIDER PLATES AS A SET.**

- 6) Remove 12 friction plates, item 715, together with 13 divider plates, item 713, and inspect for damage or wear. Plates should be flat and smooth. Plates should not show heat discoloration. Paper material on friction plates

# SERVICE INSTRUCTIONS CONTINUED

should be intact and grooved. If any damage is detected, replace friction and divider plates as a set.

- 7) Remove brake spacer, item 712.

All parts have now been removed from brake housing and there is no need for further disassembly unless a failure has been analyzed in the remaining winch assembly. If continuing, remove pipe plug, item 121, from the end cover, item 120, and tip winch to drain lubricating oil from inside of the final drive housing and cable drum.

## DISASSEMBLY OF FINAL DRIVE:

- 1) Remove retaining ring, item 124, and pull end cover, item 120, out of final housing, item 100.
- 2) Discard O-ring, item 123, and inspect planet hub stopper, item 126, and sungear stopper, item 122, for excessive wear. Replace if less than .21 inch thick.
- 3) Remove final planet hub assembly from final housing, item 100.
- 4) Inspect three final planet gears, item 320, for damage or wear. If it is necessary to remove final planet gears, remove circlip, item 311, and press planet pin, item 310, out of planet hub, item 300. Inspect loose rollers, item 323, and two thrust washers, item 321, and replace if damaged.
- 5) Remove final sungear, item 340, from cable drum, item 500.

## DISASSEMBLY OF PRIMARY DRIVE:

If primary drive requires service or repair, proceed as follows:

- 1) Turn winch over to sit flat on end of final housing, item 100. Remove four hex capscrews, item 555, with lockwashers, item 553, from each side of both tie bars, item 556, and take tie bars from the assembly.
- 2) Remove access plug, item 734, using a 1/2-13NC bolt (motor adaptor bolt, item 821, works nicely), from inside brake housing and discard O-ring, item 735.
- 3) Remove eight hex capscrews, item 537, along with lockwashers, item 541, from bearing flange, item 530, by rotating brake housing until access hole is over top of them.
- 4) Lift brake housing, together with bearing flange and primary planet hub assembly, out of cable drum, item 500, and discard O-ring, item 539.
- 5) Remove retaining ring, item 401, and remove primary planet hub assembly from inside internal gear, item 430.
- 6) Inspect three primary planet gears, item 420, for damage or wear. If it is necessary to remove primary planet gears, remove circlip, item 411, and press planet pin, item 410, out of planet hub, item 400. Inspect loose rollers, item 423, and two thrust washers, item 421, and replace if damaged.
- 7) Remove primary sungear, item 440, from center of connecting shaft, item 600.
- 8) Remove circlip, item 431, and internal gear, item 430, from connecting shaft spline.
- 9) Remove and inspect two thrust washers, item 433, and thrust bearing, item 435. Replace if cracked or otherwise damaged.
- 10) The connecting shaft, item 600, can now be pulled out of the brake housing. Remove and inspect two thrust washers, item 615, and thrust bearing, item 617. Replace if cracked or otherwise damaged.
- 11) Remove needle bearing, item 603, inspect and replace if damaged.
- 12) Remove and discard oil seal, item 607, and if present, backup washer, item 606, from inside of connecting shaft.

# SERVICE INSTRUCTIONS CONTINUED

- 13) Remove and discard oil seal, item 711, and if present, backup washer, item 710, from bore of brake housing. Inspect two need bearings, item 605, and replace if necessary.
  - 14) To separate bearing flange, item 530, and brake housing, item 700, use a standard bearing puller or insert two heel bars in the slot between the bearing flange and the brake housing and pry brake housing out of ball bearing, item 533.
  - 15) Remove internal retaining ring, item 534, to remove ball bearing, item 533. Remove and discard oil seal, item 531.
  - 16) To separate final drive housing, item 100, and cable drum, item 500, first remove external circlip, item 513, off the end of the cable drum then insert two heel bars in the slot between the final drive housing and the cable drum and pry the cable drum out of ball bearing, item 103.
  - 17) Remove internal circlip, item 109, to remove ball bearing, item 103. Remove and discard oil seal, item 105.
- The PULLMASTER Model H18 has now been completely disassembled.

## REASSEMBLY

Thoroughly clean all parts. Use only new, well-greased O-rings and oil seals. Unless otherwise specified, torque fasteners per BOLT TORQUE CHART at back of manual.

### REASSEMBLY OF FINAL DRIVE:

Reassemble final drive end of winch as follows:

- 1) Press new, well-greased oil seal, item 105, into final housing, item 100.
- 2) Press ball bearing, item 103, into final housing and secure with circlip, item 109.
- 3) Press cable drum, item 500, into ball bearing, item 103, and secure with circlip, item 513.
- 4) Reassemble final planet hub assembly. Use grease to temporarily hold 22 loose rollers, item 323, in the bore of planet gear, item 320. Position thrust washers, item 321, on either side of planet gear and press planet pin, item 310, into final planet hub, item 300. Retain with circlip, item 311.
- 5) Insert final planet hub assembly into final housing, item 100. Ensure that planet hub spline is fully engaged with cable drum, item 500.
- 6) Install new, well-greased O-ring, item 123, into end cover, item 120. Verify that planet hub stopper, item 126, and sungear stopper, item 122, are installed into end cover.
- 7) Gently insert end cover into final housing, item 100, and fasten with retaining ring, item 124.
- 8) Temporarily remove breather relief valve, item 130, from end cover. Turn winch up on end with cable drum opening upwards.

### REASSEMBLY OF PRIMARY DRIVE:

Reassemble primary drive as follows:

- 1) Press new, well-greased oil seal, item 531, into bearing flange, item 530. Press ball bearing, item 533, into bearing flange and secure with retaining ring, item 534.
- 2) Press bearing flange assembly onto brake housing, item 700, and install new, well-greased O-ring, item 539.
- 3) Press new, well-greased oil seal, item 711, into bore of brake housing, item 700.
- 4) Press new, well-greased oil seal, item 607, into bore of connecting shaft, item 600, followed by needle bearing, item 603.

# SERVICE INSTRUCTIONS CONTINUED

- 5) Slide brake hub, item 720, onto connecting shaft and secure with circlip, item 721. Place thrust bearing, item 617, sandwiched between two thrust washers, item 615, against brake hub and slide connecting shaft into brake housing.
- 6) Place thrust bearing, item 435, sandwiched between two thrust washers, item 433, onto internal gear, item 430, and fasten internal gear onto connecting shaft using circlip, item 431.
- 7) Reassemble primary planet hub assembly. Use grease to temporarily hold 20 loose rollers, item 423, in the bore of the planet gear, item 420. Verify placement of sungear stopper, item 444. Position thrust washers, item 421, on either side of the planet gear and press planet pin, item 410, into final planet hub, item 400. Retain with circlip, item 411.
- 8) Insert primary sungear, item 440, between three planet gears and insert sungear shaft into connecting shaft, engaging planet gears with internal gear. Fasten with retaining ring, item 401.
- 9) Insert final sungear, item 340, into cable drum and engage three planet gears, item 320.
- 10) Lower brake housing assembly onto cable drum, while engaging spline of final sungear with primary planet hub, item 400. Line up mounting holes of bearing flange, item 530, with those in the cable drum.
- 11) Rotate brake housing to line up access hole and fasten bearing flange using six capscrews, item 537, and lockwashers, item 541.
- 12) Install new, well-greased O-ring, item 735, into access plug, item 734. Install access plug into access hole inside brake housing.
- 13) Fasten two tie bars, item 556, using 16 capscrews, item 555, and lockwashers, item 553.

## REASSEMBLY OF BRAKE HOUSING ASSEMBLY:

Reassemble brake housing assembly as follows:

- 1) Install brake spacer, item 712, into brake housing.



**DANGER**

**INCORRECT ASSEMBLY OF THE FRICTION PLATE AND DIVIDER PLATE STACK WILL REDUCE BRAKING CAPACITY AND ALLOW THE LOAD TO DROP, CAUSING PROPERTY DAMAGE, SEVERE INJURY OR DEATH. REASSEMBLE PER INSTRUCTIONS.**

- 2) Starting and finishing with a divider plate, alternately install 13 divider plates, item 713, and 12 friction plates, item 715.
- 3) Liberally grease O-ring, item 751, and O-ring, 753, and install on brake piston, item 750.
- 4) Slide the brake piston into the brake housing with holes for the brake brings facing out of the brake housing assembly.
- 5) Install sprag clutch, item 723, and sprag clutch aligner, item 724, into the bore of connecting shaft, item 600.
- 6) Carefully slide motor drive shaft, item 730, into the connecting shaft until it engages the spline of primary sungear, item 440, and circlip, item 727, is tight against the sprag clutch aligner.

**IMPORTANT:** For proper brake function, verify that sprag clutch is installed correctly. When viewed from the motor end, the motor drive shaft of a clockwise hoisting winch must turn freely clockwise and lock in the counterclockwise direction.

# SERVICE INSTRUCTIONS CONTINUED

- 7) Install 14 brake springs, item 752, in brake piston. The brake piston has 16 holes and the two empty holes should be opposite each other.
- 8) Liberally grease three new O-rings, item 801, and install into the recesses on motor adaptor, item 800. Install new, well-greased O-ring, item 707, on flange of the motor adaptor.
- 9) Slide hydraulic motor assembly onto splined end of motor drive shaft, item 730, and line up pressure transfer holes of brake housing and motor adaptor. Install eight capscrews, item 821, and lockwashers, item 823. Tighten one turn at a time to evenly compress springs.

## REASSEMBLY OF HYDRAULIC MOTOR:

If the hydraulic motor was disassembled, the following procedure should be followed for reassembly:

- 1) Clean all parts thoroughly before reassembly and apply grease liberally to all seals. Use only new seals (seal kit Part No. 23139) for hydraulic motor.
- 2) Install two new end seals, item 887, and two new side seals, item 891, into openings in thrust plate, item 885. Install new backup seal, item 897, over top of side and end seals with tabs facing towards thrust plate. Place thrust plate assembly onto motor adaptor, item 800, with backup seal against motor adaptor.
- 3) Install gear set, item 881, into bushings, item 875. Gear with internal splines engages with motor drive shaft, item 730.
- 4) Install well-greased gasket seal, item 869, on each side of gear housing, item 861. Slide gear housing, together with gasket seals, onto motor adaptor, item 800, lined up on two dowel pins, item 865. Tap on tight using a soft headed hammer.
- 5) Install other thrust plate, complete with seals, on top of gear set with backup seal facing upwards.
- 6) Install port end cover, item 870, together with two bushings, item 875, onto the gear housing, lined up on two dowel pins, item 865. Tap on tight using a soft headed hammer. Install and lightly torque four hex capscrews, item 951, and lockwashers, item 953, to approximately 50 ft-lb (70 Nm).
- 7) Plumb winch assembly to a hydraulic supply and torque motor capscrews according to the following procedure:
  - Ensure that circulation supply flow is being supplied to the brake housing.
  - Run the winch , with no load, in the hoisting direction at reduced speed (approximately 30% of maximum hydraulic volume).
  - With winch running, evenly tighten four capscrews, item 951, to 450 ft-lb (610 Nm).
  - Test motor operation by running winch at full speed in both directions.

**IMPORTANT:** Before operating the winch, add lubricating oil up to the level of the end cover oil fill port.



**DANGER**

**LIFTING A LOAD WITH A NEWLY SERVICED WINCH COULD ENABLE AN INSTALLATION OR SERVICE PROBLEM TO GO UNDETECTED AND WILL ALLOW THE LOAD TO DROP CAUSING PROPERTY DAMAGE, SEVERE INJURY OR DEATH. TO ENSURE PROPER REINSTALLATION, REFER TO PROCEDURES AND TESTS DESCRIBED IN "INSTALLATION" AND "OPERATING INSTRUCTIONS".**

# RECOMMENDED MAINTENANCE

Winch gear train lubricating oil should be changed after the initial six months or 250 hours of operation, whichever comes first. Lubricating oil should then be changed every 12 months or 500 operating hours, whichever comes first.

Hydraulic system fluid should be changed at least once every 12 months.

For optimum performance over an extended period of time, the following preventive maintenance service should be done every 12 months or 500 operating hours (whichever comes first):

- 1) Disconnect all hydraulic hoses and remove the winch from its mounting.
- 2) Disassemble the winch as per instructions.
- 3) Discard and replace all O-rings and oil seals.
- 4) Clean all parts and inspect for wear and damage as per instructions. Replace worn or damaged parts as required.
- 5) Reassemble the winch as per instructions.
- 6) Follow INSTALLATION and OPERATING INSTRUCTIONS when returning winch to its mounting.

When ordering parts for the PULLMASTER Model H18 planetary winch, always quote the complete model and serial number of the unit.

**MODEL NO.** \_\_\_\_\_

**SERIAL NO.** \_\_\_\_\_

PULLMASTER WINCH CORPORATION reserves the right to change specifications and the design of PULLMASTER planetary winches at any time without prior notice and without incurring any obligations.

# PARTS REFERENCE - FINAL DRIVE

ITEM NO.	QTY.	PART NO.	DESCRIPTION
100	1	*	FINAL HOUSING
103	1	25150	BALL BEARING #6022
105	1	25148	OIL SEAL
109	1	25153	CIRCLIP ROTOR CLIP HO-662
120	1	21968	END COVER
121	3	25032	PIPE PLUG 1/2 - 14 NPT
122	1	19036	SUNGEAR STOPPER
123	1	25488	O-RING -280 14" ID 1/8" CS
124	1	21923	RETAINING RING INT 5/32 X 1/4 X 15.5 OD
126	1	21180	PLANET HUB STOPPER
130	1	20458	BREATHER RELIEF ASSEMBLY 1/2 NPT
300	1	21925	FINAL PLANET HUB
310	3	21940	FINAL PLANET PIN
311	3	25960	CIRCLIP ROTOR CLIP SH-131
313	3	25960	CIRCLIP ROTOR CLIP SH-131
320	3	21937	PLANET GEAR
321	6	25965	THRUST WASHER TORRINGTON #TRD 2233
323	66	25308	LOOSE ROLLER 7/32 DIA X 1.50
340	1	*	FINAL SUNGEAR
343	1	25963	CIRCLIP ANDERTON #N1400 - 0181
500	1	*	CABLE DRUM
502	1	21960	CABLE ANCHOR 3/8" TO 3/4" WIRE
513	1	25489	CIRCLIP ANDERTON #N1400 - 0425
551	*	25139	CAPSCREW - HEX HEAD 5/8 - 11NC X 1.50 GRADE 5
553	*	25359	LOCKWASHER 5/8"
554	2	*	BASE PLATE
555	16	*	CAPSCREW - HEX HEAD 5/8 - 11NC GRADE 5
556	2	*	TIE BAR

\* These parts and quantities vary according to drum code.  
Refer to APPENDIX B.

Refer to PAGE 22 for winch seal kit and PAGE 28 for ASSEMBLY DRAWING.

# FINAL DRIVE GROUP

G1043-A

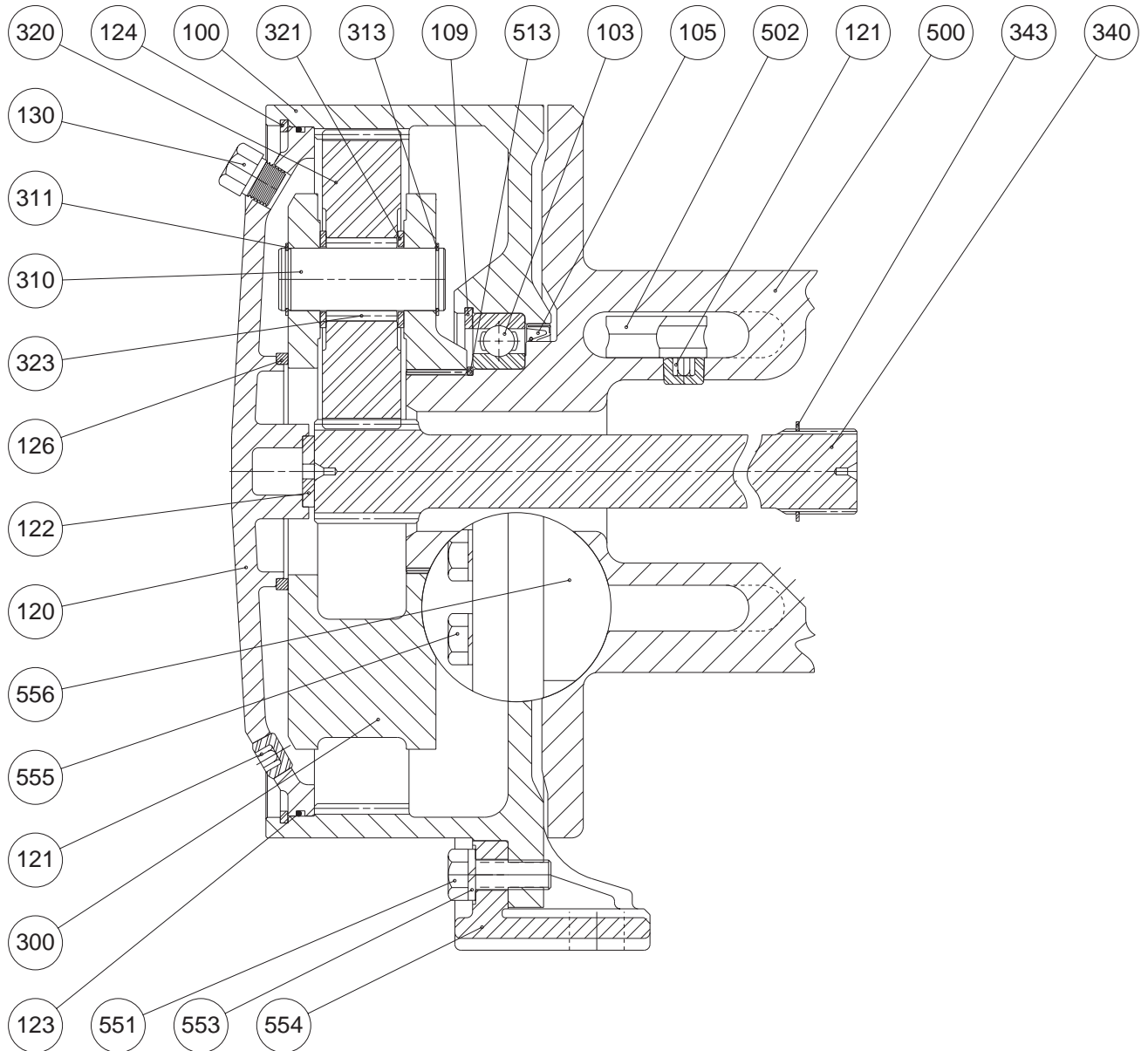

Groups drawings may reference more parts than are actually present in a specific assembly. Parts that are referenced on the drawing but are not on the PARTS REFERENCE list should be ignored.

# PARTS REFERENCE - BRAKE GROUP

ITEM NO.	QTY.	PART NO.	DESCRIPTION
400	1	21944	PLANET HUB
401	1	22093	RETAINING RING INT
410	3	21966	PLANET PIN
411	3	25961	CIRCLIP ROTOR CLIP C-81
413	3	25962	CIRCLIP ROTOR CLIP SH-81
420	3	21957	PLANET GEAR
421	6	25964	THRUST WASHER TORRINGTON #TRB 1423
423	60	25270	LOOSE ROLLER 5/32 X 1.25 TOR. #E151-Q
430	1	21943	INTERNAL GEAR
431	1	25971	CIRCLIP ROTOR CLIP SH-255
433	2	25176	THRUST WASHER TORRINGTON #TRA 5266
435	1	25177	THRUST BEARING TORRINGTON #NTA 5266
440	1	21963	PRIMARY SUNGEAR
444	1	21962	PRIMARY SUNGEAR STOPPER
530	1	21947	BEARING FLANGE
531	1	25148	OIL SEAL
533	1	25150	BALL BEARING #6022
535	1	25153	CIRCLIP ROTOR CLIP HO-662
537	8	25118	CAPSCREW - HEX HEAD 3/8 - 16NC X 1.25 GRADE 5
539	1	25966	O-RING -168 7-1/4" ID 3/32" CS
541	8	25037	LOCKWASHER 3/8"
600	1	21998	CONNECTING SHAFT
603	1	25361	NEEDLE BEARING TORRINGTON #B - 3012
605	2	25200	NEEDLE BEARING TORRINGTON #B - 4216
607	1	26009	** OIL SEAL
615	2	25365	THRUST WASHER INA #AS 90120
617	1	25364	THRUST BEARING INA # AXK 90120
700	1	*	BRAKE HOUSING
703	1	25347	PLASTIC CAPPLUG 1 - 11.5 NPT THR'D
707	1	25033	O-RING -271 9-1/4" ID 1/8" CS
711	1	25933	** OIL SEAL
712	1	21965	BRAKE SPACER
713	13	25953	DIVIDER PLATE
715	12	25952	FRICITION PLATE
720	1	21955	BRAKE HUB
721	1	25369	CIRCLIP ROTOR CLIP SH-387
723	1	25303	SPRAG CLUTCH BORG WARNER #140373 "B"
724	1	20421	SPRAG CLUTCH ALIGNER
727	1	25335	CIRCLIP ROTOR CLIP SH-196
734	1	21984	ACCESS PLUG
735	1	25967	O-RING -117 13/16" ID 3/32" CS
750	1	21936	PISTON
751	1	25968	O-RING -90 DURO -372 8-3/4" ID 3/16" CS
752	14	20413	BRAKE SPRING
753	1	25969	O-RING -90 DURO -373 9" ID 3/16" CS
		23135	WINCH SEAL KIT, CONTAINS ITEM: 105, 123, 531, 539, 607, 707, 711, 735, 751, 753 AND 801
			* These parts vary according to drum code. Refer to APPENDIX B.
			** Do not substitute. Available from PULLMASTER or Authorized Dealer only.

Refer to PAGE 28 for ASSEMBLY DRAWING.

# BRAKE GROUP

G1044

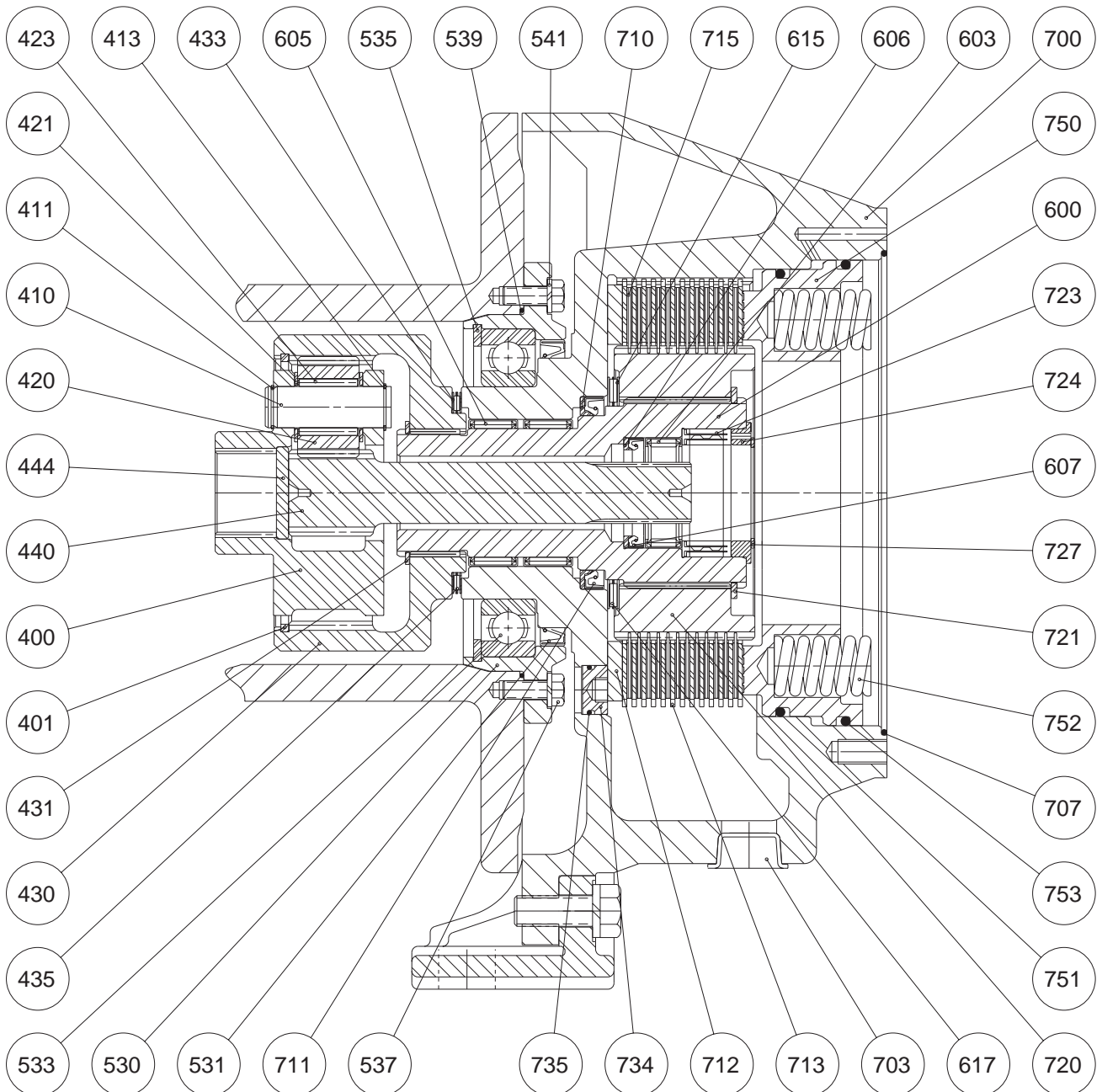

Group drawings may reference more parts than are actually present in a specific assembly. Parts that are referenced on the drawing but are not on the PARTS REFERENCE list should be ignored.

# PARTS REFERENCE - MOTOR GROUP

ITEM NO.	QTY.	PART NO.	DESCRIPTION
730	1	21322	MOTOR DRIVE SHAFT
731	1	25288	CIRCLIP ROTOR CLIP C-112
800	1	21952	MOTOR ADAPTOR
801	3	25127	O-RING 90 DURO - 013 7/16"ID 1/16" CS
802	1	*	*
805	2	25040	PIPE PLUG 1/8 - 27 NPT
806	1	*	*
807	1	*	*
809	1	*	*
813	1	25031	PIPE PLUG 1/4 -18 NPT
821	8	25081	CAPSCREW - HEX HEAD 1/2 - 13NC X 1.50 GRADE 5
823	8	25014	LOCKWASHER 1/2"
861	1	25795	GEAR HOUSING -101 COMM. #322 8222 100
865	4	25779	DOWEL PIN - HOLLOW COMMERCIAL #391 2082 069
869	2	25780	SEAL - GASKET COMMERCIAL #391 2884 023
870	1	21993	PORT END COVER M365 (INCLUDES ITEMS: 875 (x 2), 955 (x 2) & 959 (x 2))
875	4	25782	BUSHING COMM. #391 0482 307
881	1	25794	GEAR SET -101 COMM. #322 2822 000
885	2	25774	THRUST PLATE COMM. #391 2185 060
887	4	25775	SEAL - END CHANNEL COMM. #391 2885 070
891	4	25776	SEAL - SIDE CHANNEL COMM. #391 2885 069
897	2	25787	SEAL - BACKUP COMM. #391 2885 071
929	1	*	*
950	1	*	SUB-ASSY MOTOR -101 COMM. M365-2.25
951	4	25793	CAPSCREW - HEX HEAD 3/4 -10NC X 6.0" GRADE 5
953	4	25784	WASHER COMM. #391 3782 114
955	2	25585	PLASTIC CAPLUG 1.625" -12
959	2	25031	PIPE PLUG 1/4 - 18 NPT
		23139	MOTOR SEAL KIT, CONSISTS OF ITEMS: 869, 887, 891 AND 897
			<b>NOTE:</b> ITEM 950 MOTOR SUB-ASSY, CONSISTS OF ITEMS: 800, 802, 805, 806, 807, 809, 813, 861, 865, 869, 870, 875, 881, 885, 887, 891, 897, 929, 951, 953, 955 AND 959
			* These part numbers and descriptions vary according to brake code. Refer to APPENDIX C.

Refer to PAGE 22 for winch seal kit and PAGE 28 for ASSEMBLY DRAWING.

# MOTOR GROUP

G1017

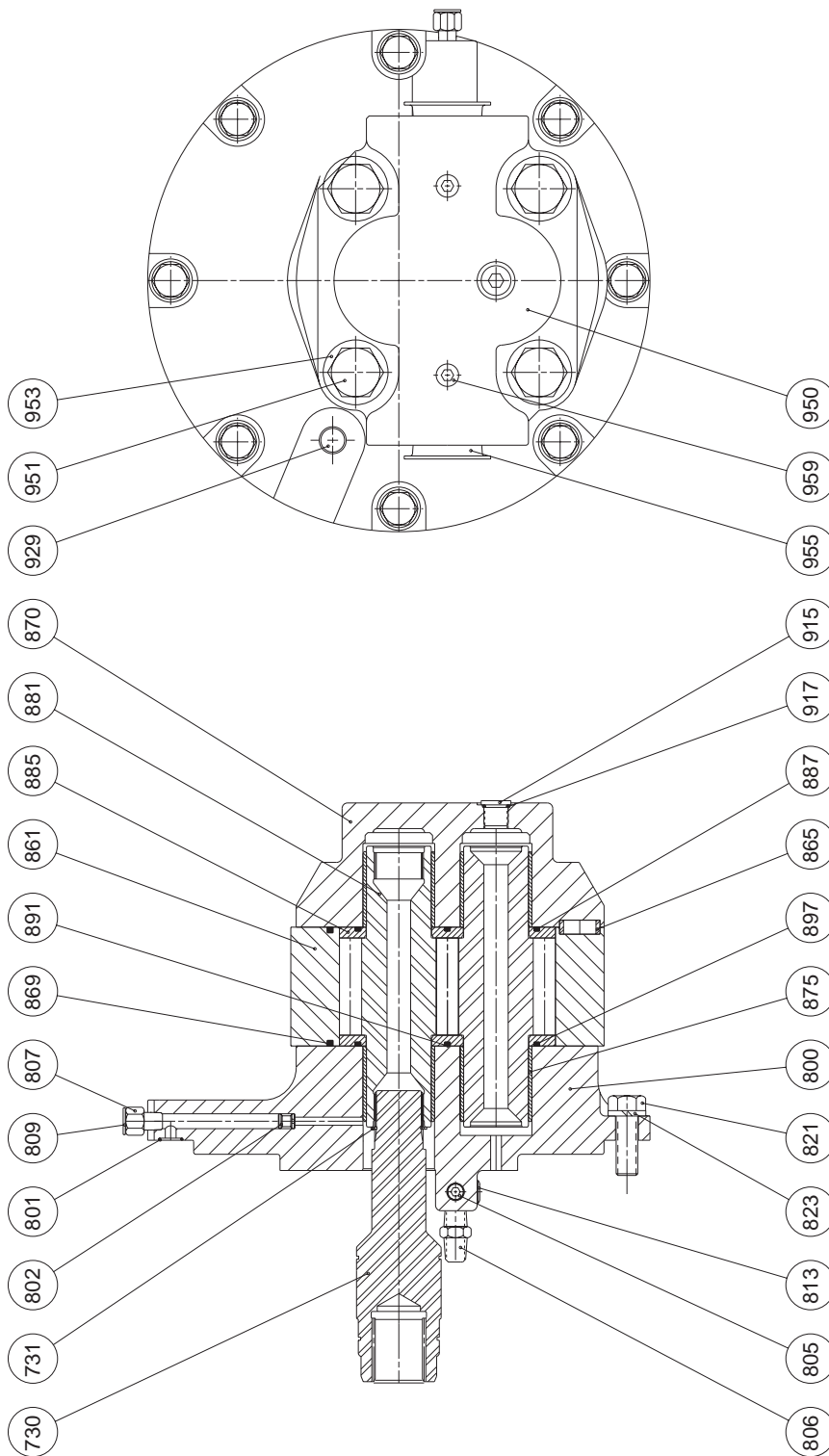

Group drawings may reference more parts than are actually present in a specific assembly. Parts that are referenced on the drawing but are not on the PARTS REFERENCE list should be ignored.

# INSTALLATION DIMENSIONS

I1068

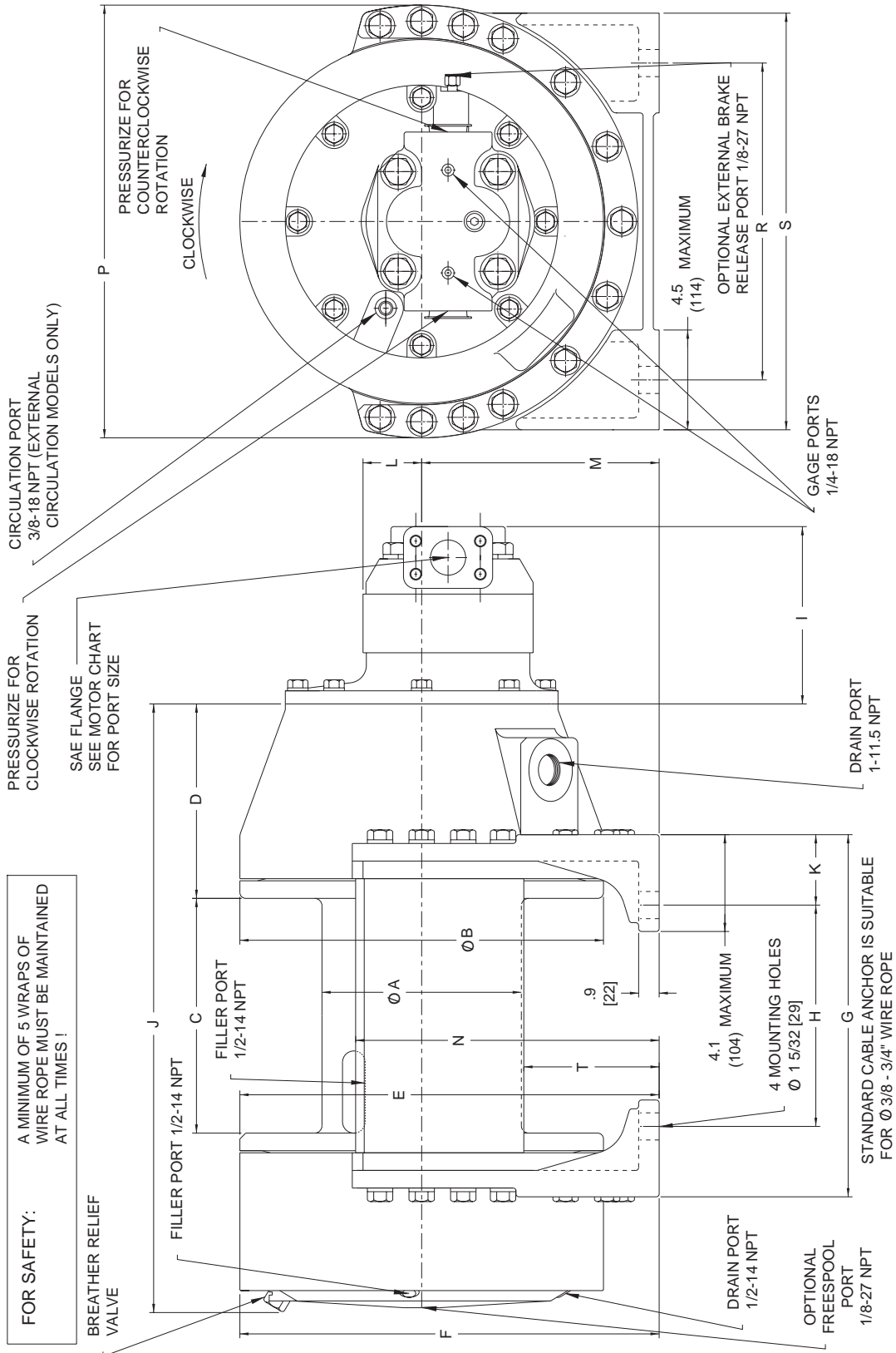

# INSTALLATION DIMENSIONS

I1023-2-F

## Dimensions in inches (Dimensions in millimeters)

DRUM CODE	A	B	C	D	E	F	G	H	J	K	M	N	P	R	S	T
-1	8.5 (216)	15.5 (394)	10.0 (254)	8.3 (210)	17.9 (454)	17.9 (454)	15.4 (392)	9.430 (239.52)	25.9 (659)	3.0 (76)	10.13 (257.2)	12.9 (329)	18.4 (468)	13.500 (342.90)	17.8 (451)	5.8 (147)
-2	13.0 (330)	20.0 (508)	16.0 (406)	8.4 (214)	20.8 (527)	18.5 (470)	22.0 (559)	18.500 (469.90)	32.2 (817)	1.8 (44)	10.75 (273.1)	13.5 (342)	23.3 (591)	17.250 (438.15)	21.6 (546)	6.3 (159)
-3	8.5 (216)	20.0 (508)	16.0 (406)	8.4 (214)	20.8 (527)	18.5 (470)	22.0 (559)	18.500 (469.90)	32.2 (817)	1.8 (44)	10.75 (273.1)	13.5 (342)	23.3 (591)	17.250 (438.15)	21.6 (546)	6.3 (159)
-4	8.5 (216)	28.0 (711)	21.3 (540)	8.8 (225)	28.8 (730)	22.5 (572)	28.1 (714)	24.187 (614.35)	38.3 (977)	1.9 (49)	14.75 (375)	16.0 (405)	31.3 (795)	20.500 (520.70)	25.0 (635)	8.8 (223)
-6	10.0 (254)	16.0 (406)	16.0 (406)	8.4 (214)	18.8 (478)	18.5 (470)	22.0 (559)	18.500 (469.9)	32.2 (817)	1.8 (44)	10.75 (273.1)	13.5 (342)	23.3 (591)	17.250 (438.15)	21.6 (546)	6.3 (159)

## Dimensions in inches (Dimensions in millimeters)

HYDRAULIC MOTORS				
COMMERCIAL M365 GEAR MOTORS				
MOTOR CODE	GEAR WIDTH	MOTOR PORT SIZE SAE 4 BOLT FLANGE	I	L
-042	2.50 (63.5)	1.50 inch Code 61	8.1 (205)	2.5 (64)
-101	2.25 (57.2)		7.8 (198)	2.5 (64)
-102	2.00 (50.8)		7.6 (192)	2.5 (64)
-128	1.75 (44.5)		7.3 (186)	2.5 (64)
-161	1.00 (25.4)		6.6 (167)	2.5 (64)
-163	1.25 (31.2)		6.9 (173)	2.5 (64)

# ASSEMBLY DRAWING

G1017 & G1043-A & G1044

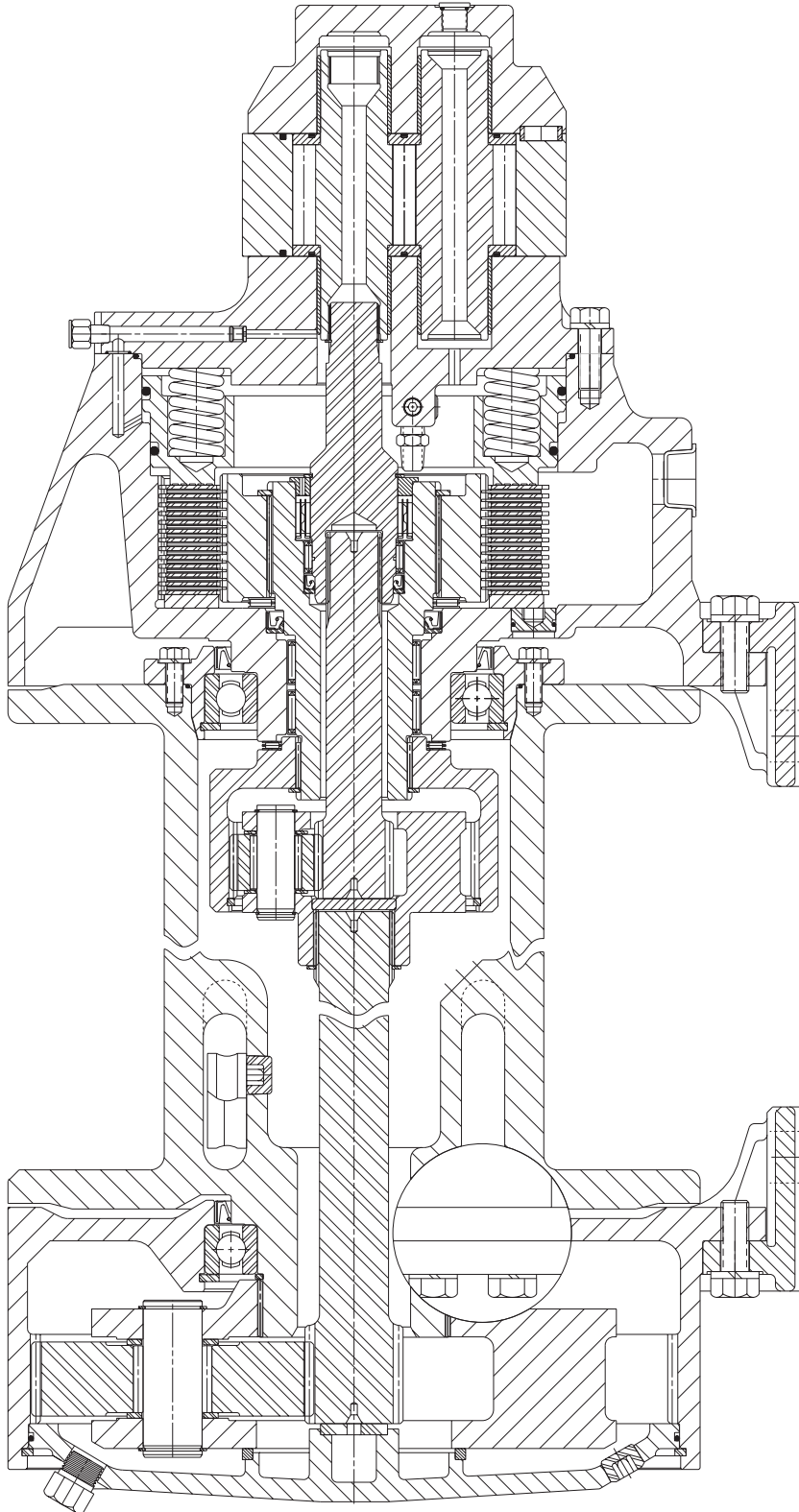

# APPENDIX A

DRUM	CABLE DRUM SIZES INCHES (MILLIMETERS)			WIRE ROPE STORAGE FEET (METERS)			LINE PULL AT MAXIMUM PRESSURE - HOISTING* POUNDS (KILONEWTONS)		HOISTING LINE SPEED AT MAXIMUM VOLUME* FEET/MINUTE (METERS/MINUTE)		MAXIMUM ALLOWABLE LINE PULL - LOWERING* POUNDS (KILONEWTONS)		LOWERING LINE AT MAXIMUM VOLUME* FEET/MINUTE (METERS/MINUTE)		LUBRICATING OIL VOLUME REQUIRED  U.S. GALLONS (LITERS)
	BARREL	FLANGE	LENGTH	7/8 in	3/4 in	5/8 in	BARE DRUM	FULL DRUM	BARE DRUM	FULL DRUM	BARE DRUM	FULL DRUM	BARE DRUM	FULL DRUM	
-1	8.5 (216)	15.5 (394)	10.0 (254)	113 (34)	170 (52)	239 (73)	18000 (80.1)	11288 (50.2)	122 (37)	195 (59)	3913 (17.4)	2506 (11.1)	563 (171)	897 (273)	1.3 (5)
-2	13.0 (330)	20.0 (508)	16.0 (406)	251 (77)	375 (114)	528 (161)	12109 (53.9)	8649 (38.5)	182 (55)	255 (78)	2632 (11.7)	1910 (8.5)	836 (255)	1171 (357)	3.7 (14)
-3	8.5 (216)	20.0 (508)	16.0 (406)	372 (113)	500 (152)	747 (228)	18000 (80.1)	8649 (38.5)	122 (37)	255 (78)	3913 (17.4)	1973 (8.8)	563 (171)	1171 (357)	2.1 (8)
-4	8.5 (216)	28.0 (711)	21.3 (541)	1068 (326)	1479 (451)	2130 (649)	18000 (80.1)	6110 (27.2)	122 (37)	360 (110)	3913 (17.4)	1385 (6.2)	563 (171)	1657 (505)	2.9 (11)

\* Performance specifications are based on standard hydraulic motor with 3/4 inch rope.

# APPENDIX B

## DRUM CODE

ITEM NO.	PART DESCRIPTION	- 1		- 2		- 3		- 4	
		PART NUMBER	QTY.	PART NUMBER	QTY.	PART NUMBER	QTY.	PART NUMBER	QTY.
100	FINAL HOUSING	21916	1	22047	1	22047	1	22047	1
340	FINAL SUNGEAR	21964	1	22050	1	22050	1	22212	1
500	CABLE DRUM	21953	1	22036	1	22398	1	22194	1
551	CAPSCREW 5/8 - 11NC x 1.5	25139	10	25139	26	25139	26	25139	26
553	5/8 LOCKWASHER	25359	26	25359	42	25359	42	25359	42
554	BASE PLATE	21926	2	22046	2	22046	2	22195	2
555	CAPSCREW 5/8 - 11NC x 2.5	25797	16	N/A	-	N/A	-	N/A	-
555	CAPSCREW 5/8 - 11NC x 2.0	N/A	-	25419	16	25419	16	25419	16
556	TIE BAR	21954	2	22045	2	22045	2	22196	2
700	BRAKE HOUSING	21950	1	22048	1	22048	1	22048	1

# APPENDIX C

## BRAKE CODE

ITEM NO.	PART DESCRIPTION	- 3	- 4	- 5	- 6	- 7	- 8	- 9	- 10
		PART NUMBERS							
802	SHUTTLE	N/A	20849	20849	N/A	N/A	20849	20849	N/A
806	CIRCULATION VALVE	20456	20456	20456	20456	N/A	N/A	N/A	N/A
806	1/4-18 NPT PIPE PLUG	N/A	N/A	N/A	N/A	25031	25031	25031	25031
807	1/8-27 NPT PIPE PLUG	25040	N/A	N/A	25040	25040	N/A	N/A	25040
807	1/8-27 NPT PIPE ADAPTOR	N/A	25622	25622	N/A	N/A	25622	25622	N/A
809	1/8 NPT CAPPLUG	N/A	25374	25374	N/A	N/A	25374	25374	N/A
929	3/8 NPT CAPPLUG	N/A	N/A	N/A	N/A	26276	26276	26276	26276
929	3/8-18 NPT PIPE PLUG	25085	25085	25085	25085	N/A	N/A	N/A	N/A
950	MOTOR SUB-ASSY	22032	22290	22291	22033	22034	22305	22306	22035

# BOLT TORQUE CHART

BOLT DIAMETER Inches	TORQUE lb-ft	TORQUE Nm
1/4	9	12
5/16	18	24
3/8	32	43
7/16	50	68
1/2	75	102
9/16	110	149
5/8	150	203
3/4	265	359
7/8	420	569
1	640	868
1 1/8	800	1085
1 1/4	1000	1356
1 3/8	1200	1627
1 1/2	1500	2034

**NOTE:** Unless otherwise specified, torque bolts per above chart.